

STANDARD BIDDING DOCUMENT

Procurement of Small Works (up to Nu 4 million)



FINANCIAL INSTITUTIONS TRAINING INSTITUTE Ltd.

Name of Work: Development of FITTI Parking Lot.

Sub- Heading: Construction of Retaining Wall and Rigid Pavement,
Ventilation works at Basement and Wooden Rack and Ladder
at Attic.

Contractor's Name:

CDB No.:

Contact No.:

INVITATION FOR BID
(IFB)

INVITATIONS FOR BIDS (IFB)
NATIONAL COMPETITIVE BIDDING

Date: 5th January 2018

Bid No.: 01/SOP/FITI/2018/009

1. The Financial Institutions Training Institute Ltd. (FITI) invites bids for the construction of FITI Parking Lot at Changeney, Thimphu.
2. Bidding documents (and additional copies) may be downloaded from www.fiti.bt website from **06/01/2018 to 26/01/2018**.
3. Bids must be accompanied by a bid security **Nu 19,000/-** drawn in favor of Chief Executive Officer, Financial Institutions Training Institute Ltd. Bid security should be in any one of the forms as specified in the bidding document and shall have validity of 30 days beyond the actual validity of the bid.
4. Bids must be delivered to the Head-HR, Admin & Finance Division, FITI on or before 1300 hours on **26th Jan 2018** and will be opened on the same day from 1430 hours in the presence of the bidders who wish to attend.

Contents

INVITATIONS FOR BIDS (IFB)	3
Section 1: Instructions to Bidder (ITB)	6
A. General	6
1. Scope of Tender.....	6
2. Corrupt Fraudulent Collusive or Coercive Practices	6
3. Eligible Bidders	7
4. Site Visit	7
B. Content of Bidding Document	7
5. Contents of Bidding Documents	7
6. Clarification of Bidding Documents	8
7. Amendment of Bidding Documents.....	8
C. Preparation of Bids	8
8. One Bid per Bidder.....	8
9. Bid Preparation Costs	8
10. Language of Bid	8
11. Documents comprising the Bid.....	8
1. Alternative Bid	8
6.2 Bid Price and Discount	8
15 Currencies of Bid and Payment.....	9
16 Documents comprising the Technical Proposal.....	9
17 Documents establishing the Qualification of the Bidder	9
18 Bid Validity.....	9
20 Format and Signing of Bid	9
D. Submission and Opening of Bids	10
21 Sealing and Marking of Bids.....	10
22 Bid Submission Deadline.....	10
23 Late Bids.....	10
24 Modification, Substitution or Withdrawal of Bids.....	10
25 Bid Opening.....	10
E. Tender Opening and Evaluation	11
26 Confidentiality	11
27 Clarification.....	11
28 Bidder: Contacting the Employer.....	11
29 Determination of Responsiveness.....	11
30 Non Conformities, Errors and Omissions	12
31 Evaluation and Comparison of Tenders.....	12
32 Employer's Right to accept or Reject any or all.....	12
F. Contract Award	12
33 Award Criteria	12
34 Letter of Intent to Award the Contract/ Notification of Award.....	12
35 Complaints	13
Section 2 - Bidding Data Sheet	14
A. General	14
B. Bidding Documents	14
C. Preparation of Bids	14
D. Submission and Opening of Bids	14
F. Award of Contract	15
Section 3 – Evaluation and Qualification Criteria	16
Section 4: Forms of Bid & Qualification Information	16
Standard Form: Form of bid	17
Standard Form: Qualification Information	18
Standard Form: Letter of Intent	19
Standard Form: Letter of Acceptance	20
Bank Guarantee for Bid Security	21

Section 5. General Conditions of Contract	22
1. Definitions	22
2. Interpretation & Documents forming the Contract	22
3. Corrupt, Fraudulent, Collusive or Coercive Practices	23
4. Governing Language and Law.....	23
5. Engineer’s Decision	23
6. Delegation.....	24
7. Communications and Notices	24
8. Sub- Contracting.....	24
9. Contractor’s Personnel	24
10. Welfare of Labourers& Child Labour	24
11. Safety, Security and Protection of the Environment.....	24
12. Access to the Site	24
13. Documents, Information.....	24
14. Property	24
15. Insurance	24
16. Possession of the Site	25
17. Commencement of Works	25
18. Completion of Works.....	25
19. Programme of Works.....	25
20. Early Warning.....	25
21. Compensation Events	25
22. Non-Scheduled Items of Works.....	25
23. Schedule of Works.....	25
24. Payment Certificates	25
25. Payments and Currency	26
26. Retention.....	26
27. Liquidated Damages	26
28. Performance Security	26
29. Price Adjustment.....	26
30. Completion	26
31. Correction of Defects.....	26
32. Taking Over.....	27
33. Final Account	27
34. Termination	27
35. Payment upon Termination	28
36. Release from Performance	28
37. Force Majeure.....	28
38. Settlement of Disputes.....	29
Section 6. Special Conditions of Contract	31
Section 7 – Contract Forms.....	Error! Bookmark not defined.
Form-1	34
Form-2	35
Contract	35
Form-3	36
Bank Guarantee for Performance Security	36
Bank Guarantee for mobilisation advance.....	37

Section 1: Instructions to Bidder (ITB)

A. General

1. Scope of the Tender
 - 1.1 The Employer, as **indicated in the BDS** issues this Bidding Document for the procurement of Works as specified in Section 6 (Employer's requirement): The name, identification and identification of this bidding are **provided in the BDS**.
 - 1.2 The successful Bidder will be required to complete the Works within the Time for Completion stated in the Special Conditions of Contract (SCC).
 - 1.3 Throughout this Bidding Documents:
 - (a) The term "in writing means communicated in written form with proof of receipt;
 - (b) If the context so requires, singular means plural and vice versa; and
 - (c) "Day" means calendar day.
2. Corrupt Fraudulent Collusive or Coercive Practices
 - 2.1 The Royal Government of Bhutan requires that Employers and the Bidders shall observe the highest standard of ethics during the implementation of procurement proceedings and the execution of Contracts under public funds.
 - 2.2 In pursuance of this requirement, the Employer shall:
 - (a) exclude the bidder from participation in the procurement proceeding concerned or reject a proposal for award; and
 - (b) Declare a bidder ineligible, either indefinitely or for a stated period of time, from participation in procurement proceedings under public funds.
 - 2.3 If it, at any time, determines that the bidder has engaged in corrupt, fraudulent, collusive or coercive practices in competing for, or in executing, a Contract under the public funds.
 - 2.4 The Government defines, for the purposes of this provision, the terms set forth below as follows:
 - a. "**corrupt practice**"¹ is the offering, giving, receiving or soliciting, directly or indirectly, of anything of value to influence improperly the actions of another party;
 - b. "**fraudulent practice**"² is any intentional act or omission including misrepresentation, that knowingly or recklessly misleads, or attempts to mislead, a party to obtain a financial or other benefits or to avoid an obligation;

¹ 'Another party' refers to a public official acting in relation to the procurement process or contract execution.

² A 'party' refers to a public official; the term 'benefit' and 'obligation' relate to the procurement process or contract execution; and the 'act or omission' is intended to influence the procurement process or contract execution.

- c. “**collusive practice**”³ is an arrangement between two or more parties designed to achieve an improper purpose, including to influence improperly the actions of another party;
 - d. “**Coercive practice**”⁴ is impairing *or* harming or threatening to impair or harm, directly or indirectly, any party or the property of the party to influence improperly the actions of a party.
 - 2.5 The bidder shall be aware of the provisions on fraud and corruption stated in GCC Clause 3 and GCC Sub-Clause 34.2(d).
 - 2.6 The RGoB requires that the Employer’s personnel have an equal obligation not to solicit, ask for and/or use coercive methods to obtain personal benefits in connection with the said proceedings.
- 3. Eligible Bidders
 - 3.1 Bidders of the categories **specified in the BDS** are eligible to participate in this bidding process.
 - 3.2 The Employer shall invite Bids using the Open Tendering Method (National Competitive Bidding) or limited tender as applicable.
 - 3.3 The bidder shall meet the qualification requirement stated in the BDS.
- 4. Site Visit
 - 4.1 The Bidders, at their own responsibility and risk, is encouraged to visit and examine the Site and obtain all information that may be necessary for preparing the bid and entering into a Contract for performance of the Works. The costs of visiting the Site shall be at the bidders’ own expense.

B. Content of Bidding Document

- 5. Contents of Bidding Documents
 - 5.1 The sections comprising the Bidding Document are listed below and should be read in conjunction with any Amendment issued in accordance with ITB Clause 7:

PART 1 Bidding Procedures

- Section 1: Instructions to Bidders (ITB)
- Section 2: Bidding Data Sheet (BDS)
- Section 3: Evaluation and Qualification Criteria
- Section 4: Bidding forms
- Section 5: General Conditions of Contract (GCC)
- Section 6: Special Conditions of Contract (SCC)
- Section 7: Contract Forms
- Section 8: Bill of Quantities & Specifications
- Section 9: Drawings

- 5.2 The Employer is not responsible for the completeness of the Bidding Document and their Addenda, if they were not obtained directly from the source stated by the Employer in the Invitation for Bids.
- 5.3 The Bidder is expected to examine all instructions, forms terms, and specifications in the Bidding Documents. Failure to furnish all information

³ ‘Parties’ refers to participations in the procurement process including public officials attempting to establish bid prices at artificial, non-competitive levels.

⁴ A ‘party’ refers to a participant in the procurement in the procurement process or contract execution.

or documentation required by the Bidding Documents may result in the rejection of the bid.

6. Clarification of Bidding Documents A prospective Bidder requiring any clarification of the Bidding Document shall contact the Employer in writing at the Employer's address **indicated in the BDS**.
7. Amendment of Bidding Documents At any time prior to the deadline for submission of Bid, the Employer may amend the Bidding Document by issuing addenda and extend the deadline for the submission of bids at its discretion. Any amendment issued shall become an integral part of the Bidding Document and shall be communicated in writing to all those who have purchased the Bidding Document.

C. Preparation of Bids

8. One Bid per Bidder A Bidder shall submit only one (1) Bid. A Bidder who submits or participates in more than one (1) Bid shall cause all the proposals with the Bidder's participation to be disqualified.
9. Bid Preparation Costs The Bidder shall bear all costs associated with the preparation and submission of its Bids, and the Employer shall in no case be responsible or liable for those costs, regardless of the conduct or outcome of the Bidding process.
10. Language of Bid All documents relating to the Bid shall be in the language specified in the BDS.
11. Documents comprising the Bid
 - 11.1 The original and copy(ies) of Bid submitted by the Bidder shall comprise the following:
 - a) The Bid form (in the format indicated in Section IV – Forms of Bid, Qualification Information, Letter of Acceptance, and Contract);
 - b) License and certificate
 - c) Bid Security in accordance with Clause 19;
 - d) Priced Bill of Quantities;
 - e) And any other materials required be completed and submitted by Bidders, as specified in the BDS.
 - 11.2 The Instruction to Bidders, Bidding Data Sheet, General Conditions of Contract, Special Conditions of Contract, Specifications and drawings are for the information of the bidders and is not required to be submitted by the bidder,
12. Letter of Bid and Schedule The letter of Bid, Schedules, and all documents listed under Clause 11, shall be prepared using the relevant forms in Section 4 (Bidding Forms), if so provided in BDS. The forms must be completed without any alterations to the text, and no substitutes shall be accepted. All blank spaces shall be filled in with the information requested.
13. Alternative Bid Alternative Bid shall not be considered in small works.
14. Bid Price and Discount
 - 14.1 The prices and discounts quoted by the Bidder in the Letter of Bid and in the Schedules shall confirm to the requirements specified below;
 - 14.2 The bidder shall submit a bid for the whole of the works described in ITB 1.1 by filling in prices for all items of the Works, as identified in Section 4, Bidding Forms. In case of admeasurements contracts, the Bidder shall fill in rates and prices for all items of the Works described in the Bill of Quantities. Items against which no rate or price is entered by

the Bidder will not be paid for by the Employer when executed and shall be deemed covered by the rates for other items and prices in the Bill of Quantities.

- 14.3 The Bid price shall take into account the cost of materials, transportation, labour, taxes, levies, overheads and profit and any other cost. The Bid price shall be fixed for the duration of performance of the Contract and shall not be subject to any adjustment on any account. The Bid price shall be applicable for the whole works described in the Drawings, Specifications and Schedule of Works.
- 15 Currencies of Bid and Payment All prices shall be quoted in Bhutanese Ngultrum (BTN) and shall be paid in BTN.
16. Documents comprising the Technical Proposal The bidder shall furnish a work plan in simple bar chart and other information if provided in BDS, to demonstrate the adequacy of the Bidders' proposal to meet the work requirements and the completion time.
17. Documents establishing the Qualification of the Bidder To establish its qualification to perform the Contract in accordance with Section 3 (Evaluation and Qualification Criteria) the Bidder shall provide the information requested in the corresponding information sheets included in Section 4 (Bidding Forms)
18. Bid Validity Bids shall remain valid for the period **specified in the BDS**. Any Bids which does not meet the validity requirement as per the BDS shall be rejected by the Employer as non-responsive.
19. Bid Security
- 19.1 The Bidder shall at their option furnish, as part of the Bid, a Bid Security as **specified in the BDS** issued by any reputed Financial Institutions in Bhutan and shall be valid thirty (30) days beyond the Bid validity period.
- Unconditional Bank Guarantee;
 - A demand Draft; or
 - Cash Warrant.
- 19.2 In exceptional circumstances, prior to the expiration of the Bid validity period, the Employer may solicit the Bidder's consent to an extension of the Bid validity period. The request and responses shall be made in writing. The validity of Bid Security shall be suitably extended promptly.
- 19.3 The Bid Security may be forfeited:
- If the Bidder withdraws the Bid after Bid opening during the period of Bid validity. Further the bidder may be excluded from future participation for a period of two years.
 - if the Bidder does not accept the correction of the Bid price, pursuant to clause 31; or
 - In the case of a successful Bidder, if the Bidder fails within the specified time limit to sign the Agreement; or furnish the required Performance Security.
- 20 Format and Signing of Bid
- 20.1 The Bidder shall prepare one (1) original of the documents comprising the Bid as described in ITB Clause 11 and clearly mark it "ORIGINAL." In addition, the Bidder shall prepare the number of copies of the Bid, as specified in the BDS and clearly mark each of them "COPY. "In the event of any discrepancy between the original and the copies, the original shall prevail.

- 20.2 The original and each copy of the Bid shall be typed or written in indelible ink and shall be signed by the person duly authorized to sign on behalf of the Bidder.
- 20.3 Any interlineations, erasures, or overwriting shall be valid only if they are signed or initialled by the person(s) signing the Bid.

D. Submission and Opening of Bids

- | | | |
|---|------|--|
| 21 Sealing and Marking of Bids | 21.1 | The Bidder shall enclose the original in one (1) envelope and all the copies of the bid in another envelope, duly marking the envelopes as “ORIGINAL” and “COPY.” These two (2) envelopes shall then be enclosed in one (1) single outer envelope. |
| | 21.2 | The inner envelopes shall: <ul style="list-style-type: none"> a) Be signed across the seals by the person authorised to sign the Bid on behalf of the Bidder; b) Be marked “ORIGINAL” and “ COPY” and c) Bear the name and address of the Bidder. |
| | 21.3 | The outer envelope shall; <ul style="list-style-type: none"> a) Be sealed with adhesive or other sealant to prevent reopening. |
| | 21.4 | Be addressed to the Employer at the address specified in the BDS; bear a statement “DO NOT OPEN BEFORE.....” the time and date for Bid opening as specified in the BDS. |
| | 21.5 | If all or any envelopes are not sealed and marked as required by ITB Sub-Clause 21, the Employer shall not reject the bids but assume no responsibility for the misplacement or premature opening of the Bid. |
| 22 Bid Submission Deadline | 22.1 | Bids must be received by the Employer at the address and no later than the date and time specified in the BDS. |
| | 22.2 | Bids may be hand delivered, posted by registered mail or sent by courier. |
| | 22.3 | The Employer may, at its discretion, extend the deadline for the submission of Bids by amending the Bidding Document in accordance with ITB Clause 7, in which case all rights and obligations of the Employer and Bidders previously subject to the deadline shall thereafter be subject to the new deadline as extended. |
| 23 Late Bids | | Late bids shall not be considered and shall be returned unopened |
| 24 Modification, Substitution or Withdrawal of Bids | | A Bidder may modify, substitute or withdraw their Bids after it has been submitted by sending a written notice before the deadline for submission of Bids. |
| 25 Bid Opening | 25.1 | The Employer shall open the Bids in the presence of the bidders who are attending the bid opening, including modifications or substitutions made pursuant to ITB Clause 24. Bidders or their representatives shall be allowed to attend and witness the bid opening and shall sign a register evidencing their attendance. |

- 25.2 The name of the Bidder, Bid modifications, substitutions or withdrawals, total amount of each Bid, number of corrections, discounts, and the presence or absence of requisite Bid Security, and such other details as the Employer, at its discretion, may consider appropriate, shall be read out aloud and recorded.
- 25.3 The Employer shall prepare minutes of the Bid opening. The minutes shall include, as a minimum, the name of the Bidders and whether there has been a withdrawal, substitution or modification; the Bid Price including any discounts and the presence or absence of a Bid Security, if one was required.
- 25.4 Bids not opened and read out at the Bid opening shall not be considered, irrespective of the circumstances, and shall be returned unopened to the Bidder.

E. Tender Opening and Evaluation

- 26 Confidentiality After the opening of Bids, information relating to the examination, clarification, and evaluation of Bids and recommendations for award shall not be disclosed to Bidders or other persons not officially concerned with the evaluation process until after the award of the Contract is announced.
- 27 Clarification The Employer may ask Bidders for clarification of their Bids in order to facilitate the examination and evaluation of Bids. The request for clarification and the response shall be in writing, and any changes in the prices or substance of the Bid shall not be sought, offered or permitted, except to confirm the correction of arithmetical errors discovered by the Employer in the evaluation of the Bids, in accordance with ITB Clause 31.
- 28 Bidder: Contacting the Employer Following the opening of Bids and until the Contract is signed no Bidder shall make any unsolicited communication to the Employer or try in any way to influence the Employer's examination and evaluation of Bids which may result in the rejection of bids. If any Bidder wishes to contact the Employer on any matter related to the Bidding process, it should do so in writing
- 29 Determination of responsiveness
 - 29.1 Prior to detailed evaluation of bids, the employer shall determine whether each bid (a) meets the eligibility criteria defined in ITB clause 3; (b) has been properly signed; (c) is accompanied by the bid security; and (d) is substantially responsive to the requirements of the bidding documents.
 - 29.2 A substantially responsive Bid is one that conforms in all respects to the requirements of the Bidding Document without material deviation, reservation or omission. A material deviation, reservation or omission is one that:
 - (a) affects in any substantial way the scope, quality, or performance of the Works specified in the Contract; or
 - (b) limits in any substantial way, or is inconsistent with the Bid Document, the Employer's rights or the Bidder's obligations under the Contract; or
 - (c) If rectified would unfairly affect the competitive position of other Bidders presenting substantially responsive Bids.
 - 29.3 If a Bid is not substantially responsive to the Bidding Document it shall be rejected by the Employer and shall not subsequently be made

responsive by the Bidder by correction of the material deviation, reservation or omission.

- 29.4 There shall be no requirement as to the minimum number of responsive Bids.
- 30 Non Conformities, Errors and Omissions The Employer may regard a Bid as responsive even if it contains minor deviations that do not materially alter or depart from the characteristics, terms, conditions and other requirement set forth in the Bidding Document or if it contains errors or oversights that are capable of being corrected without affecting the substance of the Bid.
- 31 Evaluation and Comparison of Tenders
- 31.1 The Employer shall evaluate and compare only those Bids determined to be substantially responsive to the requirements of the Bidding Document. Substantially responsive Bids are those, which fulfil the requirements of ITB Clauses 11 and 12.
- 31.2 The evaluation will take into account corrected Bid Price and discounts (if any).
- 31.3 The Employer will check substantially responsive Bids for any arithmetical errors. Where there is a discrepancy between the amounts in figures and words, the amount in words will govern. If a Bidder refuses to accept the correction, its Bids shall be rejected. The Employer shall correct arithmetical errors on the following basis:
- (a) if there is a discrepancy between the unit price and the line item total, the unit price shall prevail and the total price shall be corrected, unless in the opinion of the Employer there is an obvious misplacement of the decimal point in the unit price, in which case the total price, as quoted, shall govern and the unit price shall be corrected; and
- 32 Employer's Right to accept or Reject any or all The Employer reserves the right to accept any Bid, to annul the Bid proceedings, or to reject any or all Bids, at any time prior to Contract award, without thereby incurring any liability to Bidders, or any obligation to inform Bidders of the grounds for the Employer's actions.

F. Contract Award

- 33 Award Criteria The Employer shall award the Contract to the Bidders whose offer is substantially responsive to the Bidding Document and that has been determined to be the lowest evaluated Bid, provided that the Bidder is determined to be qualified to perform the Contract satisfactorily
- 34 Letter of Intent to Award the Contract/ Notification of Award
- 34.1 The Employer shall notify the concerned Bidder whose bid has been selected in accordance with ITB 33.1 in writing (in the format in Section 4- hereafter called the "Letter of Intent to Award) that the Employer has intention to accept its bid and the information regarding the name, address and amount of selected bidder shall be given to all other bidders who submitted the bid. Such notification should be communicated in writing, including by cable, facsimile, telex or electronic mail to all the bidders on the same day of dispatch. The Employer shall ensure that the same information is uploaded on their website on the same day of dispatch.

- 34.2 If no bidder submits an application pursuant to ITB 35 within a period of ten (10) days of the notice provided under ITB 34.1, Prior to the expiration of the period of Bid validity, the Employer shall notify the successful Bidder, in writing that its Bid has been accepted. Until a formal contract is prepared and executed, the Notification of Award shall constitute a binding Contract.
- 34.3 Within fifteen (15) working days of the receipt of the Notification of Award from the Employer, the successful Bidder shall furnish the Performance Security, in the amount specified in the BDS.
- 34.4 The proceeds of the performance security shall be payable to the Employer unconditionally upon first written demand as compensation for any loss resulting from the Contractor's failure to complete its obligations under the Contract.
- 34.5 Within fifteen (15) working days of receipt of the notification of award, the successful Bidder shall sign, date and return it to the Employer.
- 35 Complaints
- 35.1 The Bidder shall submit the complaint in writing within ten (10) days from the date of letter of intent to award the contract pursuant to ITB 34.1 to the Employer.
- 35.2 The Bidder may appeal to the Independent Review Body only if the Employer has not delivered the decision within the specified time, or the complainant is not satisfied with the decision of the Employer in accordance with rules and procedures of Independent Review Body.

Section 2 - Bidding Data Sheet

Instructions for completing the Bidding Data Sheet are provided, as needed, in the notes in italics mentioned for the relevant ITB Clauses

ITB Clause **Amendment of, and Supplements to, Clauses in the Instructions to Bidders**

A. General

- ITB 1.1 The Employer is **Chief Executive Officer, Financial Institutions Training Institute Ltd**
The Name and Identification of the Contract is/are **Construction of Retaining Wall and Rigid Pavement, Ventilation works at Basement and Wooden Rack and Ladder.**
- ITB3.2 **Option B: Open Tendering method**
All Bidders regardless of whether enlisted or not enlisted with the Dzongkhag may submit Bids provided they otherwise qualify.
- ITB 3.3 The evaluation shall be based on the lowest price of the responsive bidder and the work will awarded to the lowest responsive bidder.

B. Bidding Documents

- ITB 7.1 For clarification of Tenders purposes only, the Employer's address is:

Attention: **Head, HR, Admin and Finance**
Address:**FITI, Post Box 1621, Changeney, Thimphu**
Telephone:**02-336631**
Electronic mail address: **head.hradmin@fiti.bt**

C. Preparation of Bids

- ITB 15.1 The Bid validity period shall be sixty days (60).
ITB 15.2 A Bid Security in the amount of Nu- **19,000/-** will be required, in the form:
a) Unconditional Bank guarantee or
b) Cash warrant; or
c) Demand draft
- ITB 16.1 A simple bar chart is *required*.
- ITB 19.1 In addition to the original, *one* copy shall be submitted.

D. Submission and Opening of Bids

- ITB 17.2 The inner and outer envelopes shall bear the following additional identification marks: As specified under ITB 21

ITB 17.2 For **Bid submission purposes** only, the Employer's address is:

Attention: **Head, HR, Admin and Finance**
Address: **FITI, Post Box 1621, Changueny, Thimphu**

The deadline for the submission of Tenders is: Time & Date **1.00 pm on 26th Jan 2018**

ITB 21.1 The Bid opening shall take place on the same day as the closing day of the bid submission at:

Venue: FITI Boardroom
Date: 26th Jan 2018
Time: from 2:30 pm

E. Award of Contract

ITB 34.2 The amount of Performance Security shall be 10% of the Contract Price.

Section 3: Evaluation and Qualification Criteria

This section contains all the criteria that the Employer shall use to evaluate bids and qualify Bidders if the bidding was not preceded by a prequalification exercise and post qualifications are applied. Procuring Agency may apply basic minimum technical qualification requirement (manpower and equipment) only if there is a project specific need.

1. **Evaluation** - Evaluation shall be done to determine the responsiveness and the award shall be made to the lowest evaluated bidder.

Section 4: Forms of Bid & Qualification Information

Table of Standard Forms

Standard Form:	Form of Bid
Standard Form:	Letter of Intent
Standard Form:	Letter of Acceptance
Standard Form:	Bid Security/ Bank Guarantee

Standard Form: Form of Bid

Notes on Form of Bid: The Bidder shall fill in and submit this bid form with the Bid. If Bidders do not fill in the Contract Price and does not sign this Bid form, the bids will be rejected.

_____ [Date]

To: _____

Address: _____

We offer to execute the contract for construction of “_____” in accordance with the Conditions of Contract accompanying this Bid for the Contract Price of Nu. _____ (_____) [amount in words] _____ [name of currency].

The contract shall be paid in Ngultrum (Nu.).

This Bid and your written acceptance of it shall constitute a binding Contract between us. We understand that you are not bound to accept the lowest or any Bid you receive.

We hereby confirm that this Bid complies with the Bid validity and Bid Security required by the bidding documents and specified in the Bidding Data.

Authorized Signature: _____

(Affix Legal Stamp)

Name and Title of Signatory: _____

Name of Bidder: _____

Address: _____

Standard Form: Qualification Information

Notes on Form of Qualification Information: The following information is to be filled in by bidders, which will be used for purposes of evaluation

1. Individual bidders

1.1 Constitution of legal status of Bidder [attach copy]

Place of registration: _____

Principal place of business: _____

Power of attorney of signatory of Bid [attach]

1.2 Qualifications and experience of key personnel proposed for administration and execution of the Contract. Refer BDS. The supporting documents such as latest updated CVs signed in original supported by certificates for qualification and experience.

Position	Name	Qualification & yrs. of experience (general)	Year of experience in proposed position	Remarks
Supervisor				

Standard Form: Letter of Intent

(Letterhead paper of the Employer)

Notes on standard form of letter of Intent

This issuance of Letter of Intent (always before letter of acceptance) is the information of the selection of the bid of the successful bidder by the Employer and for providing information to other unsuccessful bidders who participated in the bid as regards the outcome of the procurement process.

The Employer shall allow 10 days as described in ITB 34.2 between this letter of intent and letter of acceptance to allow aggrieved bidders to challenge your decision if they feel they have treated unfairly.

(Insert date)

To: ----- *[Name and address of the Contractor]*

This is to notify you that, it is our intention to award the contract for your Bid dated-----
[Insert date] for execution of the----- *[Insert name of the contract and identification number, as given in the BDS/SCC]* for the Contract Price of-----
[Insert amount in figure and words and name of currency] as corrected and modified*[if any corrections]* in accordance with the Instructions to Bidders.

Authorized Signature: -----

Name and Title of Signatory: -----

Name of Agency: -----

CC: *[Insert name and address of all other bidders who submitted the bid]*

Standard Form: Letter of Acceptance

[Letterhead paper of the Employer]

Notes on Standard Form of Letter of Acceptance - The Letter of Acceptance will be the basis for formation of the Contract as described in Clauses 31 and 32 of the Instructions to Bidders. This Standard Form of Letter of Acceptance should be filled in and sent to the successful Bidder only after evaluation of bids has been completed.

_____ [Date]

To: _____ [*Name of the Contractor*]
_____ [*Address of the Contractor*]

This is to notify that your Bid dated _____ for the execution of the contract for the construction of “_____” for the Contract Price _____
[*amount in numbers*] _____
[*amount in words*] _____ [*name of currency*], as corrected and modified in accordance with the Instructions to Bidders is hereby accepted by our Agency. The start date of the project is _____. The completion date for whole of the works shall be _____.

You are hereby instructed to proceed with the execution of the said Works in accordance with the Contract documents.

Authorized Signature: _____

Name and Title of Signatory: _____

Name of Agency: _____

Attachment: Agreement

Bank Guarantee for Bid Security

[This is the format for the Bid Security to be issued by a financial institution in Bhutan in accordance with ITB Clause 19]

Invitation for Bid No: _____ Date: _____

Bid Package No: _____

To:

_____ [Name
and address of Employer]

TENDER GUARANTEE No:

We have been informed that [*name of Bidder*] (hereinafter called “the Bidder”) intends to submit to you its Bid dated [*date of bid*] (hereinafter called “the Tender”) for the execution of the Works of [*description of works*] under the above Invitation for Bids (hereinafter called “the IFB”).

Furthermore, we understand that, according to your conditions a Bid Guarantee must support Bid.

At the request of the Bidder, we [*name of bank*] hereby irrevocably undertake to pay you, without cavil or argument, any sum or sums not exceeding in total an amount of Nu [*insert amount in figures and words*] upon receipt by us of your first written demand accompanied by a written statement that the Bidder is in breach of its obligation(s) under the Bid conditions, because the Bidder:

- (a) has withdrawn its Bids during the period of Bid validity specified by the Bidder in the Form of Bid;
or
- (b) does not accept the correction of errors in accordance with the Instructions to Bidders ITB; or
- (c) having been notified of the acceptance of the Bid by the Employer during the period of Bid validity,
 - (i) fails or refuses to furnish the performance security in accordance with the ITT, or
 - (ii) fails or refuses to execute the Contract Form,

This guarantee will expire

- (a) if the Bidder is the successful Bidder, upon our receipt of a copy of the Performance Security and a copy of the Contract signed by the Bidder as issued by you; or
- (b) If the Bidder is not the successful Bidder, thirty days after the expiration of the Bidder’s Tender validity period, being [*date of expiration of the Tender*].

Consequently, we must receive at the above-mentioned office any demand for payment under this guarantee on or before that date.

Signature

Signature

Section 5. General Conditions of Contract

1. Definitions
 - 1.1 The following words and expressions shall have the meaning hereby assigned to them. Boldface type is used to identify the defined terms:
 - a) **Completion Certificate** means the Certificate issued by the Employer as evidence that the Contractor has executed the Works in all respects as per drawing, specifications, and Conditions of Contract.
 - b) The **Completion Date** is the date of completion of the Works as certified by the Engineer, in accordance with GCC Clause 18.
 - c) **Contract** means the Agreement entered into between the Employer and the Contractor to execute, complete and maintain the Works.
 - d) **Contractor** means the person or corporate body whose Tender to carry out the Works has been accepted by the Employer and is named as such in the SCC.
 - e) **Contract Price** is the price stated in the Letter of Acceptance and thereafter as adjusted in accordance with the provisions of the Contract. The **Contractor's Bid** is the completed Bid Document including the priced offer submitted by the Contractor to the Employer.
 - f) **Days** mean calendar days.
 - g) A **Defect** is any part of the Works not completed in accordance with the Contract.
 - h) The **Employer** is the party named in the SCC who employs the Contractor to carry out the Works.
 - i) The **Engineer** is the person named in the SCC, who is responsible for supervising the execution of the works and administering the Contract.
 - j) The **Intended Completion Date** is the date specified in the SCC on which the Contractor shall complete the Works and may be revised if extension of time or an acceleration order is issued by the Engineer.
 - k) The **Site** is the area defined as such in the SCC.
 - l) The **Works** are what the Contract requires the Contractor to construct, install, and hand over to the Employer, as defined in the SCC.
 - 2.1 In interpreting the GCC, singular also means plural, male also means female or neuter, and the other way around. Headings in the GCC shall not be deemed part thereof or be taken into consideration in the interpretation or construance of the Contract. Words have their normal meaning under the language of the Contract unless specifically defined.
 - 2.2 The following documents forming the Contract shall be interpreted in the following order of priority:
 - a) The signed Contract Agreement.
 - b) The letter of Notification of Award.
 - c) The completed Bid form as submitted by the Bidder.
 - d) The Special Conditions of Contract.
 - e) General Conditions of Contract.
 - f) Specifications
 - g) The Drawings.
 - h) Any other document listed in the PCC as forming part of the Contract.
2. Interpretation & Documents forming the Contract

- | | |
|---|--|
| 3. Corrupt, Fraudulent, Collusive or Coercive Practices | <p>3.1 The Government requires that Employers, as well as Contractors shall observe the highest standard of ethics during the implementation of procurement proceedings and the execution of Contracts under public funds.</p> <p>3.2 In pursuance of this requirement, the Employer shall</p> <ul style="list-style-type: none"> a) exclude the Contractor from participation in the procurement proceedings concerned or reject a proposal for award; and b) Declare a Contractor ineligible, either indefinitely or for a stated period of time, from participation in procurement proceedings under public fund. <p>3.3 The Government defines, for the purposes of this provision, the terms set forth below as follows:</p> <ul style="list-style-type: none"> (a) corrupt practice⁵⁵ is the offering, giving, receiving or soliciting, directly or indirectly, of anything of value⁶ to influence improperly the actions of another party; (b) “fraudulent practice”⁷ is any intentional act or omission, including a misrepresentation, that knowingly or recklessly misleads, or attempts to mislead, a party to obtain a financial or other benefit or to avoid an obligation; (c) “collusive practice”⁸ is an arrangement between two or more parties designed to achieve an improper purpose, including to influence improperly the actions of another party; and (d) “Coercive practice”⁹ is impairing or harming, or threatening to impair or harm, directly or indirectly, any party or the property of the party to influence improperly the actions of a party. <p>3.4 The Government requires that the Client’s personnel have an equal obligation not to solicit, ask for and/or use coercive methods to obtain personal benefits in connection with the said proceedings.</p> |
| 4. Governing Language and Law | <p>The Contract as well as all correspondence and documents relating to the Contract exchanged by the Contractor and the Employer, shall be written in English unless otherwise stated in the SCC. The Contract shall be governed by and interpreted in accordance with the laws of the Kingdom of Bhutan.</p> |
| 5. Engineer’s Decision | <p>Except where otherwise specifically stated in the SCC, the Engineer will decide Contractual matters between the Employer and the Contractor in the role as representative of the Employer.</p> |

⁵⁵“Another party” refers to a public official acting in relation to the procurement process or contract execution. In this context, “public official” includes staff and employees of any organizations (including any institutions providing finance for the Works) taking or reviewing procurement decisions.

⁶“anything of value” includes, but is not limited to, any gift, loan, fee, commission, valuable security or other asset or interest in an asset; any office, employment or contract; any payment, discharge or liquidation of any loan, obligation or other liability whatsoever, whether in whole or in part; any other services, favor or advantage, including protection from any penalty or disability incurred or apprehended or from any action or proceeding of a disciplinary or penal nature, whether or not already instituted and including the exercise or the forbearance from the exercise of any right or any official power or duty.

⁷a “party” refers to a public official; the terms “benefit” and “obligation” relate to the procurement process or contract execution; and the “act or omission” is intended to influence the procurement process or contract execution.

⁸“Parties” refers to participants in the procurement process (including public officials) and an “improper purpose” includes attempting to establish bid prices at artificial, non-competitive levels.

⁹A “party” refers to a participant in the procurement process or contract execution.

6. Delegation The Engineer may delegate any of his duties and responsibilities to his representative, after notifying the Contractor, and may cancel any delegation, without retroactivity, after notifying the Contractor.
7. Communications and Notices Communications between Parties pursuant to the Contract shall be in writing to the address specified in the SCC. A notice shall be effective when delivered or on the notice's effective date, whichever is later.
8. Sub- Contracting The Contractor shall not be permitted to subcontract any part of the Works in whole or in part.
9. Contractor's Personnel The Contractor shall employ the key personnel named in the Schedule of Key Personnel, as referred to in the SCC, to carry out the functions stated in the Schedule, or other personnel approved by the Engineer.
10. Welfare of Laborers & Child Labor
- 10.1 The Contractor shall provide proper accommodation to his labourers and arrange proper water supply, conservancy and sanitation arrangements at the site in accordance with relevant regulations, rules and orders of the government.
- 10.2 The Contractor shall comply with the applicable minimum age, labour laws and requirements of (including applicable treaties which have been ratified by) the Government of Bhutan regarding hazardous forms of child labour.
11. Safety, Security and Protection of the Environment The Contractor shall throughout the execution and completion of the Works and the remedying of any defects therein:
- a) have full regard for the safety of all persons entitled to be upon the Site and keep the Site and the Works in an orderly state;
 - b) provide and maintain at the Contractors own cost all lights, guards, fencing, warning signs and watching for the protection of the Works or for the safety on-site; and
 - c) take all reasonable steps to protect the environment on and off the Site and to avoid damage or nuisance to persons or to property of the public or others resulting from pollution, noise or other causes arising as a consequence of the Contractors methods of operation.
12. Access to the Site The Contractor shall allow the Engineer and any person authorised by the Engineer access to the Site and to any place where work in connection with the Contract is being carried out or is intended to be carried out.
13. Documents Information. The Contractor shall furnish to the Engineer all information, schedules, calculations and supporting documentation that may be requested of it.
14. Property If the contract is terminated by the Employer because of the contractor's default then, the contractor shall not be allowed to remove any materials from the Site, Plant, and Temporary Works until the matter is amicably resolved.
15. Insurance
- 15.1 The Contractor shall provide insurance as stated in the SCC;
- 15.2 The Contractor shall deliver policies and certificates of insurance to the Engineer, for the Engineer's approval, before the Start Date;
- 15.2 If the Contractor does not provide any of the policies and certificates required, the Employer may affect the insurance which the Contractor should have provided and recover the premiums the Employer has paid from payments otherwise due to the Contractor

- or, if no payment is due, the payment of the premiums shall be a debt due.
16. Possession of the Site The Employer shall give possession of the Site, or parts of the Site, to the Contractor on the date(s) specified in the SCC.
17. Commencement of Works
- 17.1 The Contractor may commence execution of the Works on the Start Date, or other such date as specified in the SCC, and shall carry out the Works in an expeditious manner.
- 17.2 If the Contractor fails to commence the works within the above stated period, the Employer may, at his sole discretion, terminate the Contract and forfeit the Performance Security, if any.
18. Completion of Works The Contractor shall complete the Works within the number of days stated in the SCC from the date of commencing the Works on the Site.
19. Programme of Works Within the time stated in the SCC, the Contractor shall submit to the Engineer for approval a work program. The Contractor shall submit to the Engineer for approval an updated Programme at intervals no longer than the period stated in the SCC.
20. Early Warning The Contractor shall warn the Engineer at the earliest opportunity of specific likely future events or circumstances that may adversely affect the quality of the work result in increase to the Contract Price or delay in the execution of the Works.
21. Compensation Events
- 21.1 The following shall be Compensation Events:
- a) the Employer does not give access to the Site or part of the Site by the Site Possession Date stated in the SCC; and
 - b) If the payment is delayed pursuant to Clause 25.1.
- 21.2 If a Compensation Event would prevent the work being completed before the Intended Completion Date, the Intended Completion Date shall be extended, as appropriate, by the Engineer.
22. Non-Scheduled Items of Works The Contractor shall be paid for non-scheduled items of works only when the Engineer approves such works and at the rates and in the manner stated in the SCC.
23. Schedule of Works
- 23.1 The Schedule of Works will contain rates for all items for the construction including temporary works, installation, testing, and commissioning work to be done by the Contractor.
- 23.2 The Contractor shall be paid for the quantity of the work done at the rate in the Contract for each item.
- 23.3 The Contractor shall be entirely responsible for all taxes, duties, license fees, and other such levies imposed outside and inside Bhutan.
24. Payment Certificates
- 24.1 The Contractor shall submit to the Engineer monthly statements of the estimated value of the work executed less the cumulative amount certified previously. The Engineer shall check the Contractor's monthly statement and certify the amount to be paid to the Contractor.
- 24.2 The value of work executed shall be determined by the Engineer.
- 24.3 The value of work executed shall comprise the value of the quantities of the items in the Schedule of Works completed.

- 24.4 The value of work executed shall include the valuation of Variations, Certified Day works and Compensation Events.
- 24.5 The Engineer may exclude any item certified in previous certificates or reduce the proportion of any item previously certified in any certificate in the light of later information.
25. Payments and Currency
- 25.1 The Employer shall pay the Contractor the amounts certified by the Engineer within thirty days (30) of the date of each certificate.
- 25.2 The Employer shall make Advance Payment (mobilization and secured advance) to the Contractor of the amounts and by the dates stated in the SCC against provision by the Contractor of an unconditional Bank Guarantee, (Form 4).
- 25.3 The Contractor is to use the advance payment only to pay for Equipment, Plant, Materials, and mobilisation expenses required specifically for the execution of the Contract. The Contractor shall demonstrate that the advance payment has been used in this way by submitting copies of invoices or other documents to the Employer.
- 25.4 The advance payment shall be repaid by deducting proportionate amounts from payments otherwise due to the Contractor, following the schedule of completed percentages of the Works on a payment basis. No account shall be taken of the advance payment or its repayment in assessing valuations of work done, variations, claims or any amount payable due to failure to complete the works.
26. Retention
- 26.1 The Employer shall retain from each payment due to the Contractor the proportion stated in the SCC until the completion of the whole of the Works.
- 26.2 On completion of the whole of the Works, half the total amount retained shall be repaid to the Contractor, the remaining half when the Defects Liability Period has passed and the Engineer has certified that all Defects notified by the Engineer to the Contractor before the end of this period have been corrected.
27. Liquidated Damages
- The Contractor shall pay liquidated damages to the Employer at the rate per day stated in the SCC for each day that the Completion Date is later than the Intended Completion date for the works or for any part thereof.
28. Performance Security
- Upon Notification of Award, a Performance Security shall be provided to the Employer in the amount and form stated in the Contract Forms (Form 3). The Performance Security shall be valid until a date thirty days (30) from the date of issue of the Certificate of Completion.
29. Price Adjustment
- The rates and prices in the bill of quantities are fixed for the duration of the Contract and not subject to price adjustment during the performance of the Contract.
30. Completion
- The Contractor shall request the Engineer to issue a Certificate of Completion of the Works, and the Engineer will do so upon deciding that the work is substantially completed.
31. Correction of Defects
- 31.1 The Engineer shall give notice to the Contractor of any Defects before the end of the Defects Liability Period, which begins at

Completion, and is defined in the SCC. The Defects Liability Period shall be extended for as long as the Defects remain to be corrected.

- 31.2 If the Contractor has not corrected a Defect within the time specified in the Engineer's notice, the Engineer will assess the cost of having the Defect corrected, and the Contractor will pay this amount.
32. Taking Over The Employer shall take over the Site and the Works within seven (7) days of the Engineer issuing a Certificate of Completion.
33. Final Account 33.1 The Contractor shall supply the Engineer a detailed account of the total amount that the Contractor considers payable under the Contract. The Engineer shall certify any final payment that is due to the Contractor within twenty-one (21) days of receiving the Contractor's account if it is correct and complete.
- 33.2 The Employer shall effect payment of the final account within thirty days (30) from the date of certification by the Engineer.
34. Termination 34.1 The Employer or the Contractor by giving thirty (30) days written notice of default to the other party, may terminate the Contract in whole or in part if the other party causes a fundamental breach of Contract.
- 34.2 Fundamental breaches of the Contract shall include, but shall not be limited to, the following:
- a) the Contractor stops work for more than thirty (30) days when no stoppage of work is shown on the current Programme and the stoppage has not been authorised by the Engineer;
 - b) the Engineer gives notice that failure to correct a particular defect is a fundamental breach of Contract and the Contractor fails to correct it within a reasonable period of time determined by the Engineer;
 - c) the Contractor has delayed the completion of the Works by the number of days for which the maximum amount of Liquidated Damages can be paid;
 - d) the Contractor, in the judgment of the Employer, has engaged in corrupt or fraudulent practices, as defined in GCC Clause 3, in competing for or in executing the Contract; and
 - e) A payment certified by the Engineer is not paid to the Contractor by the Employer within sixty (60) days of the date of the Engineer's certificate.
- 34.3 The Employer and the Contractor may at any time terminate the Contract by giving notice to the other party if either of the parties becomes bankrupt or otherwise insolvent. In such event, termination will be without compensation to any party provided that such termination will not prejudice or affect any right of action or remedy that has accrued or will accrue to the other party.
- 34.4 Notwithstanding the above, the Employer may terminate the Contract for convenience.

- 34.5 If the Contract is terminated, the Contractor is to stop work immediately, make the Site safe and secure and hand over the Site to the Employer as soon as reasonably possible.
35. Payment upon Termination
- 35.1 If the Contract is terminated because of a fundamental breach of Contract by the Contractor, the Engineer shall issue a certificate for the value of the work done and Plant and Materials ordered less advance payments received up to the date of the issue of the certificate and less the percentage to apply to the value of the work not completed, as indicated in the SCC.. Additional Liquidated Damages shall not apply. If the total amount due to the Employer exceeds any payment due to the Contractor, the difference shall be a debt payable to the Employer.
- 35.2 If the Contract is terminated for the Employer's convenience or because of a fundamental breach of Contract by the Employer, the Contractor shall be entitled to payments for completed works and the materials that have been brought to the site for the purpose of the works, but not used as certified by the Engineer after adjusting any payments received by the Contractor.
36. Release from Performance
- If the Contract is frustrated by the outbreak of war or by any other event entirely outside the control of either the Employer or the Contractor, the Engineer shall certify that the Contract has been frustrated. The Contractor shall make the Site safe and stop work as quickly as possible, after receiving this certificate. The Contractor shall be paid for all works carried out before stoppage of work and any work carried out afterwards to which a commitment was made.
37. Force Majeure
- 37.1 For the purposes of this Contract, "Force Majeure" means an exceptional event or circumstance:
- a) which is beyond a Party's control,
 - b) which such Party could not reasonably have provided against before entering into the Contract,
 - c) which, having arisen, such Party could not reasonably have avoided or overcome, and
 - d) Which is not substantially attributable to the other Party.
- 37.2 Force Majeure may include, but is not limited to, exceptional events or circumstances of the kind listed below, so long as conditions (a) to (d) above are satisfied:
- a) war, hostilities (whether war be declared or not), invasion, act of foreign enemies,
 - b) rebellion, terrorism, sabotage by persons other than the Contractor's Personnel, revolution, insurrection, military or usurped power, or civil war,
 - c) riot, commotion, disorder, strike or lockout by persons other than the Contractor's Personnel,
 - d) munitions of war, explosive materials, ionizing radiation or contamination by radio-activity, except as may be attributable to the Contractor's use of such munitions, explosives, radiation or radio-activity, and
 - e) Natural catastrophes such as earthquake, hurricane, typhoon or volcanic activity.
- 37.3 However, force majeure shall not include the following;

- a) rainfall
 - b) snowfall
 - c) strikes in other countries
 - d) Non-availability of labourer and materials such as timbers, boulders, sand, and other materials difficulty and risky terrain and remoteness of site.
38. Settlement of Disputes
- 38.1 The Employer and the Contractor shall use their best efforts to settle amicably all disputes arising out of or in connection with this Contract or its interpretation.
- 38.2 Any dispute between the parties to the Contract that may not be settled amicably will be referred to Arbitration at the initiative of either of the parties.
- 38.3 The Arbitration shall be conducted in accordance with the Arbitration Rules of the Kingdom of Bhutan in force.

Section 6. Special Conditions of Contract

Instructions for completing the Special Conditions of Contract are provided, as needed, in the notes in italics mentioned for the relevant GCC Clauses.3

Clause Ref Amendments of, and Supplements to, Clauses in the General Conditions of Contract

- GCC 1.1(d) The Contractor is [*name, address and name of authorised representative*].
- GCC 1.1(i) The Employer is Chief Executive Officer, FITI, Thimphu
- GCC 1.1(j) The Engineer is
- GCC 1.1(k) The Intended Completion Date for the whole of the Works shall be **60 days**.
- GCC 1.1(l) The Site is located **In front of FITI office Near DYS**.
- GCC 1.1(m) The Works are **PCC, stone soling, HDPE pipe, MS railing, ventilations, ladder, RRM wall, etc.**
- GCC 2.2(i) The additional documents forming part of this Contract are: ***Integrity Pact (IP). The IP shall be signed over legal stamp and submitted during the submission. Non-submission and non-signing bid shall be rejected.***
- GCC 4.1 The Language governing the Contract shall be *English*.
- GCC 5.1 The Engineer shall obtain specific approval of the Employer before taking any of the following actions:
- GCC 7.1 The addresses for Communications shall be:
- For the Employer:
- Chief Executive Officer, FITI, Changeney, Thimphu**
- 02 336631**
- For the Contractor: [*insert name, address and contact details*].
- GCC 9.1 The Key Personnel of the Contractor are: **One Site Supervisor with Minimum VTI passed out in Civil field. The following documents are required to be submitted duly signed by himself/herself**
- a) **VTI certificate**
 - b) **ID card**
 - c) **Experience certificates**
 - d) **CVs**

If the above personal is not present at site, Nu 15,000/month shall be deducted and if not submitted, the bid shall be rejected during evaluation.

- GCC 15.1 For insurance purposes the type of cover required shall be: The contractor shall be responsible for the insurance
- GCC 16.1 Possession of the site shall be within **7 days** from the date of signing of the Contract.
- GCC 17.1 Commencement of work shall be within **7 days** from the date of handing over possession of the Site.
- GCC 18.1 Completion of works shall be within **60 days** from the date of commencing the works on the site.
- GCC 19.1 The Contractor shall submit the first work plan 5 days after signing the Contract, and shall update the work plan every 2 weeks during the period of the Contract.
& 19.2
- GCC 22.1 [Enter here the agreed rates for non-scheduled items of work if known, if not known then make the statement “The rates for non-scheduled items of works shall be determined by the Engineer”.*NA*
- GCC 25.2 An advance payment of **10%** of the Contract Price will be made to the Contractor within 14 days of Contract signing date.
- GCC 26.1 The Retention shall be *10%* of the Contract Price.
- GCC 27.1 The liquidated damages for the whole of the Works are *0.10 %* per day.

The maximum amount of liquidated damages for the whole of the Works is *10* percent of the initial Contract Price.
- GCC 31.1 The Defects Liability Period shall be **6 (six) months**.
- GCC 35.1 The percentage to apply to the value of the work not completed, representing the Employer’s additional cost for completing the Works, is **20% of the value of work not completed up to a maximum of 10% of the initial contract price.**

Section 7 – Contract Forms

This section contains forms that, once completed, will form part of the Contract. The successful Bidder shall, only complete the forms for Performance Security and Advance Payment Security when required, after Contract award.

Contract Forms

Form:	Title
Form-1:	Notification of Award
Form-2:	Contract Agreement
Form-3:	Bank Guarantee for Performance Security
Form-4:	Bank Guarantee for Advance Payment

Notification of Award

Contract No:

Date:

To: _____ *[name and address of Contractor]*

This is to notify you that your Bid dated *[insert date]* for the execution of the Works for *[name of project / Contract]* for the Contract Price of Nu *[amount in figures and in words]* as corrected and modified in accordance with the Instructions to bidder is hereby accepted by *[name of the Employer]*.

You are requested to proceed with the execution of the Works on the basis that this Notification of Award shall constitute the formation of a Contract, which shall become binding upon you furnishing a Performance Security within fourteen (14) days, in accordance with ITB Clause 32, and the signing the Contract within twenty-one (21) days, in accordance with ITB Clause 33.

We attach the Contract and Special Conditions of Contract for your perusal and signature.

Signed

Duly authorised to sign for and on behalf of
[name of Procuring Entity]

Date:

Contract

THIS AGREEMENT, made the [day] of [month] [year] between [name and address of Employer] (hereinafter called “the Employer”) of the one part and [name and address of Contractor] (hereinafter called “the Contractor”) of the other part.

WHEREAS, the Employer invited Tenders for certain Works, viz, [brief description of the Works] and has accepted a Tender by the Contractor for the execution of those works in the sum of Ngultrum [insert amount in figures and words], hereinafter called “the Contract Price.

NOW THIS AGREEMENT WITNESSETH as follows:

1. In this Agreement, words and expressions shall have the same meanings as are respectively assigned to them in the General Conditions of Contract hereinafter referred to.
2. The documents forming the Contract shall be interpreted in the following order of priority:
 - (a) The signed Contract Agreement;
 - (b) The letter of Acceptance;
 - (c) The completed Bid form as submitted by the Bidder;
 - (d) The Special Conditions of Contract;
 - (e) The General Conditions of Contract;
 - (f) Specifications
 - (g) The Drawings; and
 - (h) Any other document listed in the SCC as forming part of the Contract.
3. In consideration of the payments to be made by the Employer to the Contractor as hereinafter mentioned, the Contractor hereby covenants with the Employer to execute and complete the Works and to remedy any defects therein in conformity in all respects with the provisions of the Contract.
4. The Employer hereby covenants to pay the Contractor in consideration of the execution and completion of the Works and the remedying of defects therein, the Contract Price or such other sum as may become payable under the provisions of the Contract at the times and in the manner prescribed by the Contract.

IN WITNESS whereof the Parties thereto have caused this Agreement to be executed in accordance with the laws of Bhutan on the day month and year first before written.

For the Employer

For the Contractor

Signature

Print Name

Title

In the presence
of (Name)

Address

Bank Guarantee for Performance Security

[This is the format for the Performance Security to be issued by any financial institute in Bhutan in accordance with **ITB** Clause 35]

Contract No:

Date:

To: _____
[Name and address of Employer]

PERFORMANCE GUARANTEE No:

We have been informed that *[name of Contractor]* (hereinafter called “the Contractor”) has undertaken, pursuant to Contract No *[reference number of Contract]* dated *[date of Contract]* (hereinafter called “the Contract”), the execution of works *[description of works]* under the Contract.

Furthermore, we understand that, according to your conditions, Contracts must be supported by a performance guarantee.

At the request of the Contractor, we *[name of bank]* hereby irrevocably undertake to pay you, without cavil or argument, any sum or sums not exceeding in total an amount of Nu *[insert amount in figures and in words]* upon receipt by us of your first written demand accompanied by a written statement that the Contractor is in breach of its obligation(s) under the Contract conditions, without you needing to prove or show grounds or reasons for your demand of the sum specified therein.

This guarantee is valid until *[date of validity of guarantee]*, consequently, we must receive at the above-mentioned office any demand for payment under this guarantee on or before that date.

Signature

Signature

Bank Guarantee for mobilisation advance

[This is the format for the Advance Payment Guarantee to be issued by a financial institutions in Bhutan in their letter pad in accordance with SCC Clause 25.2]

Contract No:

Date:

To: _____
[Name and address of Employer]

ADVANCE PAYMENT GUARANTEE No:

We have been informed that *[name of Contractor]* (hereinafter called “the Contractor”) has undertaken, pursuant to Contract No *[reference number of Contract]* dated *[date of Contract]* (hereinafter called “the Contract”), the execution of works *[description of works]* under the Contract.

Furthermore, we understand that, according to your conditions, Advance Payments must be supported by a bank guarantee.

At the request of the Contractor, we *[name of bank]* hereby irrevocably undertake to pay you, without cavil or argument, any sum or sums not exceeding in total an amount of Nu *[insert amount in figures and in words]* upon receipt by us of your first written demand accompanied by a written statement that the Contractor is in breach of its obligation(s) under the Contract conditions, without you needing to prove or show grounds or reasons for your demand of the sum specified therein.

We further agree that no change, addition or other modification of the terms of the Contract to be performed, or of any of the Contract documents which may be made between the Employer and the Contractor, shall in any way release us from any liability under this guarantee, and we hereby waive notice of any such change, addition or modification.

This guarantee is valid until *[date of validity of guarantee]*, consequently, we must receive at the above-mentioned office any demand for payment under this guarantee on or before that date.

Signature

Signature

Section 8 Bill of Quantities (BOQ)

Name of Work: Detail Estimate of Parking in front of FITI Building

Location: Changeney, Thimphu.

Note:

1. Space for labour camp and store may not adequate, therefore contractor may have to make own arrangement.
2. Contractor should inspect the site before submitting the bid.
3. All concreting work shall be done using concrete mixture. Manual mixture not permitted.

Sl. No.	Code No.	Description of Items	Qty.	Unit	Rate	Amount
A	Retaining Wall And Rigid Pavement					
		Earthwork				
1	RW0006	Earthwork in excavation over areas, exceeding 300mm in depth, 1.5 m in width as well as 10 m ² on plan including disposal of excavated earth (disposed earth to be levelled and neatly dressed) Ordinary Soil. No measurement for extra width.	53.57	m ³		
2	RW0035	Filling of trenches, sides of foundations, walls, etc. including filter material (600mm wide) with 100 to 200mm stones wherever applicable including filling with selected portable compactor, watering etc. within 50m lead (compacted), consolidating each layer with power roller or excavated material in layer not exceeding 200mm in depth suitable.	392.91	m ³		
		Stone Works				
3	SM0072	Providing and laying Hand packed stone filling or soling with stones	91.88	m ³		
4	SM0005	Providing & laying Random Rubble Masonry with hard stone in foundation & plinth, In cement mortar 1:4	72.73	m ³		
		PCC Works				

Sl. No.	Code No.	Description of Items	Qty.	Unit	Rate	Amount
5	CW0005	Providing and laying in position plain cement concrete including the cost of centering and shuttering - All work up to plinth level.	64.90	m ³		
		Steel Works				
6	SW0022	Steel work welded, in built up sections, trusses, frame-works including cutting, hoisting, fixing and applying priming coat of red lead paint - In Tubular sections. 50mm diameter (3.61kg/m)	451.11	kg		
7	PT0047	Providing and applying finishing coats - Synthetic enamel, for steel & wood work, two coats on new work	15.44	m ²		
		Plastering Works				
8	PL0031	Providing & laying 15mm cement plaster on rough side of wall	29.71	m ²		
		Weep Hole				
9	PI0014	Providing & fixing PVC pipe as weep hole at 2m c/c complete 50mm diameter.	16.80	m		
		Drainage				
10	PO0052	Providing & laying H.D.P.E Pipes, 4 PN, including H.D.P.E fittings and trenching and backfilling. 160mm	24.00	m ²		
		Total: A				
B	Ventilation works at Basement					
11	DD0011	Demolishing brick masonry including stacking useful materials & disposal of rubbish within 50m lead.	0.15	m ³		
12	PL0125	Providing & applying putty of thickness 2mm or more over plastered surface to prepare the surface even and smooth complete.	1.56	m ²		
13	PT0010	Providing & applying one coat of cement primer	3.48	m ²		
14	PT0040	Providing and applying finishing coats. Dry distemper, two coats on new work, including white priming coat. Painting has to be same as other walls nearby.	7.32	m ²		

Sl. No.	Code No.	Description of Items	Qty.	Unit	Rate	Amount
15	SW0045	Providing & fixing anodized Aluminium section for ventilators of specified sections including all accessories such as U-rubber gasket for fixing glass panes, weather strips or weather seals, roller, springs, etc. complete including the cost of glass panes complete. Louvered windows with plain glass 6mm thick.	0.60	m ²		
		Total B:				
C	Wooden Rack and Ladder					
16	WW0470	Providing & fixing smooth finished wooden shelves 50x50mm thick post, 12.5mm thick wooden planks as plate and sliding flush door shutters (pre-fabricated), block-board core supported on 40x40x6mm 'T' or 'L' iron brackets fixed at each joint as per drawings/site engineer instructions. This work includes nails/screws, SS hinges, lock/ handle with lock, slider/roller, wooden primer, polish/synthetic enamel paints, etc. complete. Hard wood.	32.92	m ²		
17		Providing & fixing/placing Aluminum ladder as per design with hook at top and railing of both sides. As per the specification and drawings/picture. Before supplying, approvals need to be accorded.	1.00	each		
		Total C:				
		Grand Total A+B+C:				

Section 9. Drawings

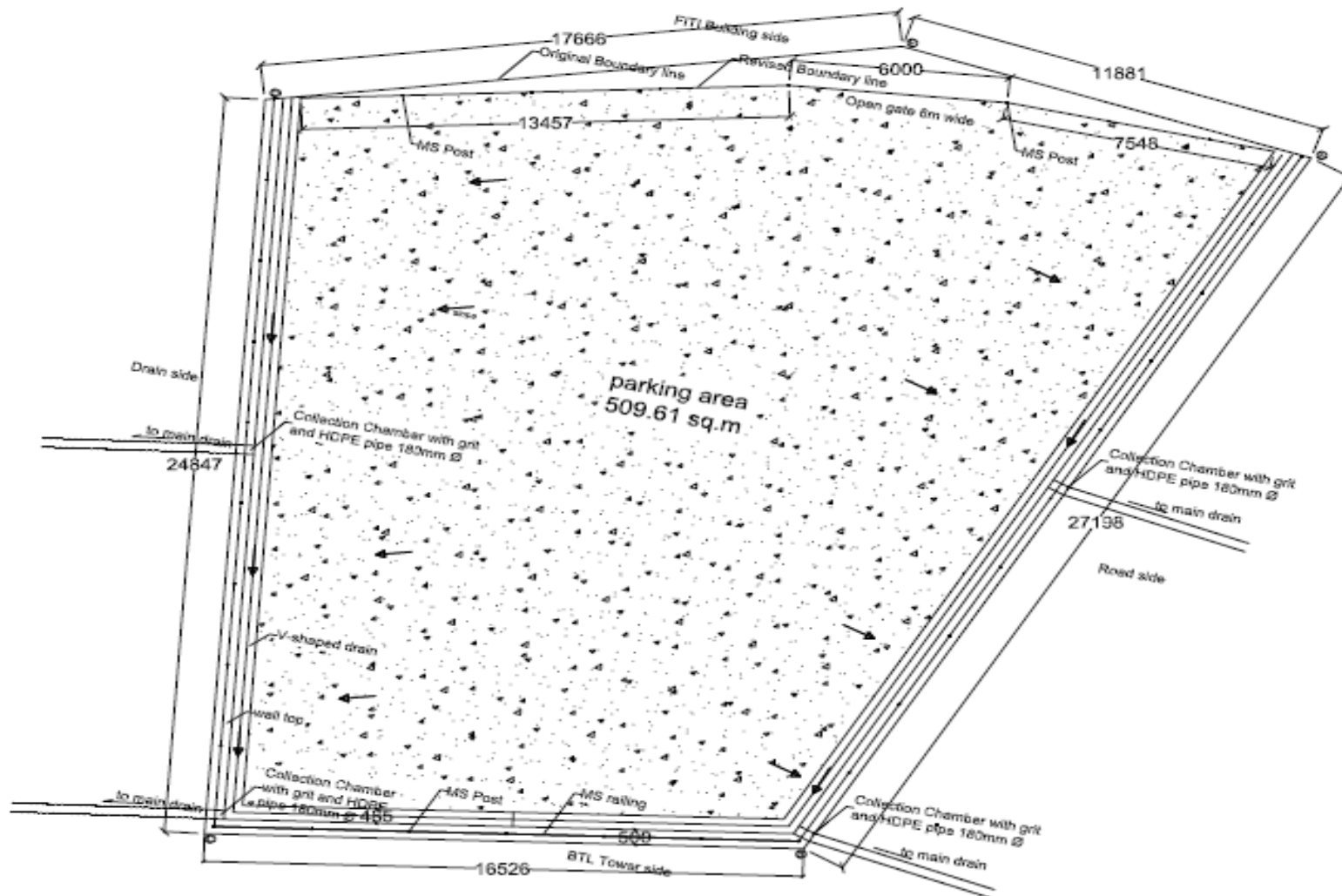

REVISION	DATE	DESCRIPTION	Financial Institutions Training Institute Ltd. Changney, Thimphu, Bhutan. Tel.: +975-93366351 Fax: +975-9336632 Email: projectmanager@fiti		Name of work: Parking Development Works	No. PLAN		Sheet No.	
1					H/TI Changney, Thimphu	Drawn by: Sagar Proshan, Project Manager	Checked by: Kampha Jamel, Director	Nov. 2017	
2								Page No. 001	
3									
4									

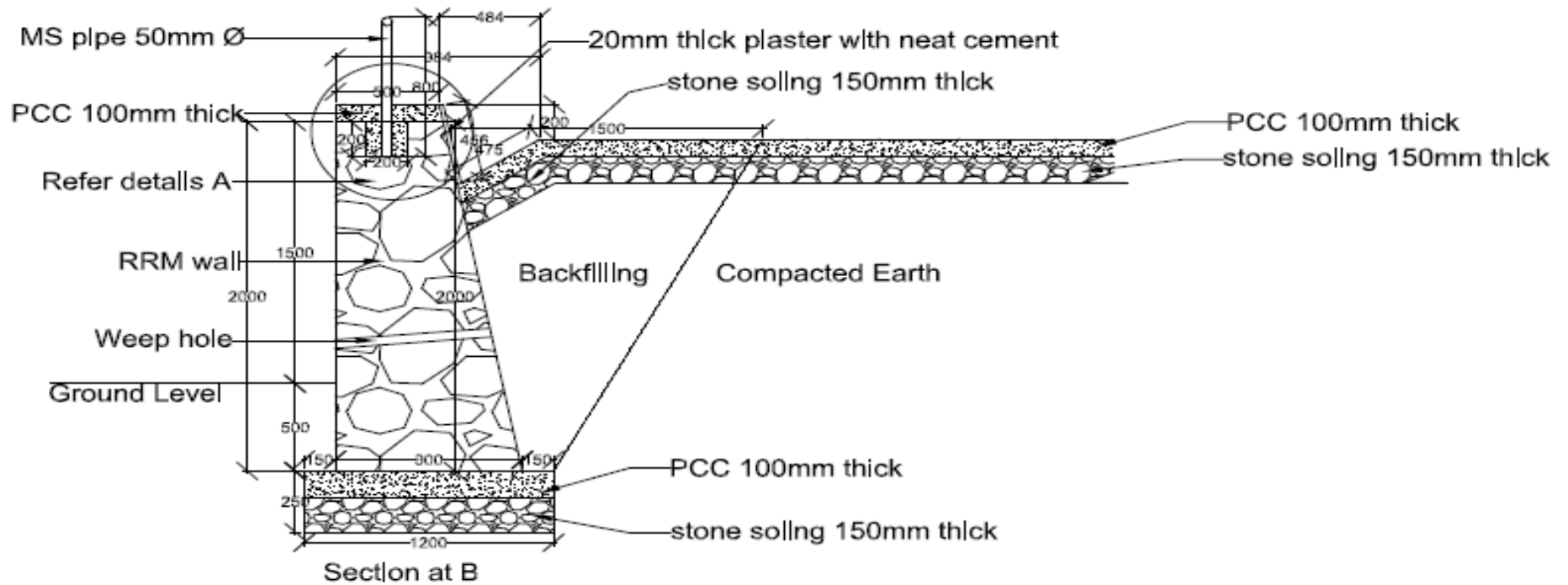

REVISION	DATE	DESCRIPTION	 Financial Institutions Training Institute Ltd. Changarney, Thimphu, Bhutan. Tel: +975-0-3366361 Fax: +975-0-336632 Email: project.manager@fti.ltd	Name of work: Parking Development Works		SECTION		Sheet No.
1				FTI, Changarney, Thimphu	Drawn by: Supan Pradhan, Project Manager Checked by: Namgyal Dorji, Director	SECTION	SECTION	Nov, 2017
2								Page No. 002
3								
4								

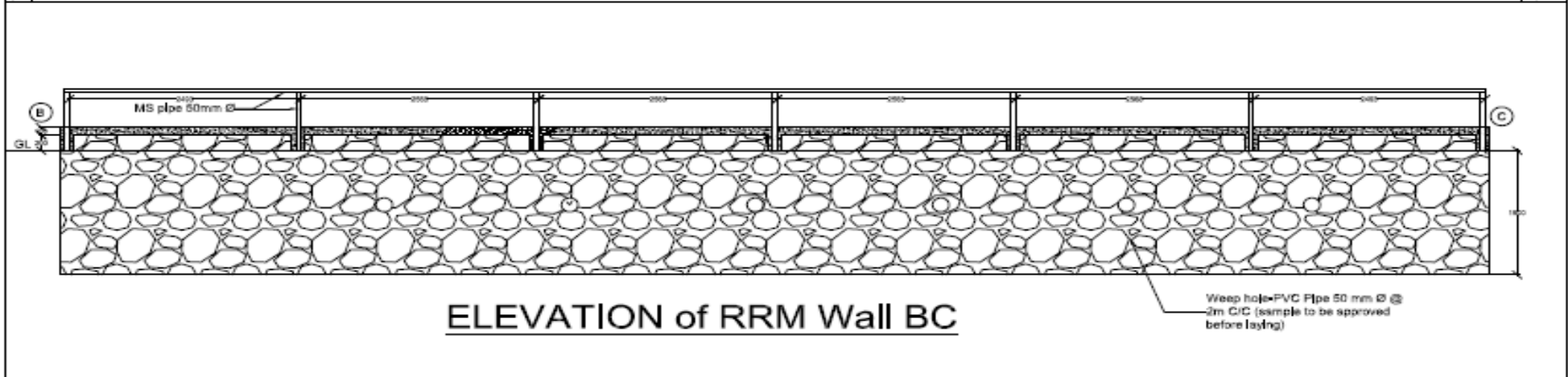
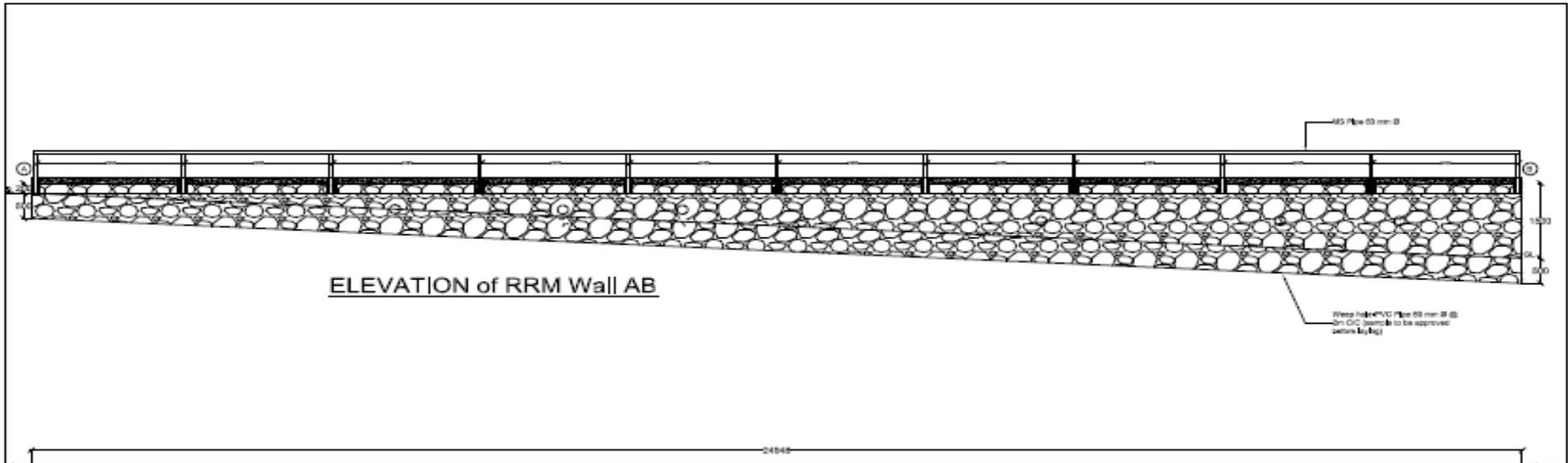

REVISION	DATE	DESCRIPTION	 Financial Institutions Training Institute Ltd. Changenery, Tiruppu, Sholan. Tel: +915403366361 Fax: +91540336632 Email: projectmanager@fti.tn	Name of work: Parking Development Works		No: ELEVATION		Sheet No.
1				H/I Changenery, Tiruppu	Drawn by: Sujan Pradhan, Project Manager	Checked by: Ranjita Jena, Director	Nov.2017	Page No. 004
2								
3								
4								

Dimensions of RRM wall and work have to be executed as per table and typical drawings provided.

Works	No.	Length	Breadth 1	Breadth 2	Avg. Breadth	Height 1	Height 2	Avg. Height
Earthwork								
RRM wall AB	1	27.20	0.80	1.20	1.00	0.75	0.75	0.75
RRM wall BC	1	15.41	1.20	1.20	1.20	0.75	0.75	0.75
RRM wall CD	1	25.73	1.20	0.80	1.00	0.75	0.75	0.75
RRM wall								
RRM wall AB	1	27.20	0.80	0.90	0.85	0.70	2.00	1.35
RRM wall BC	1	15.41	0.90	0.90	0.90	2.00	2.00	2.00
RRM wall CD	1	25.73	0.90	0.80	0.85	2.00	0.70	1.35

RACK DRAWINGS-PLAN AND ELEVATION

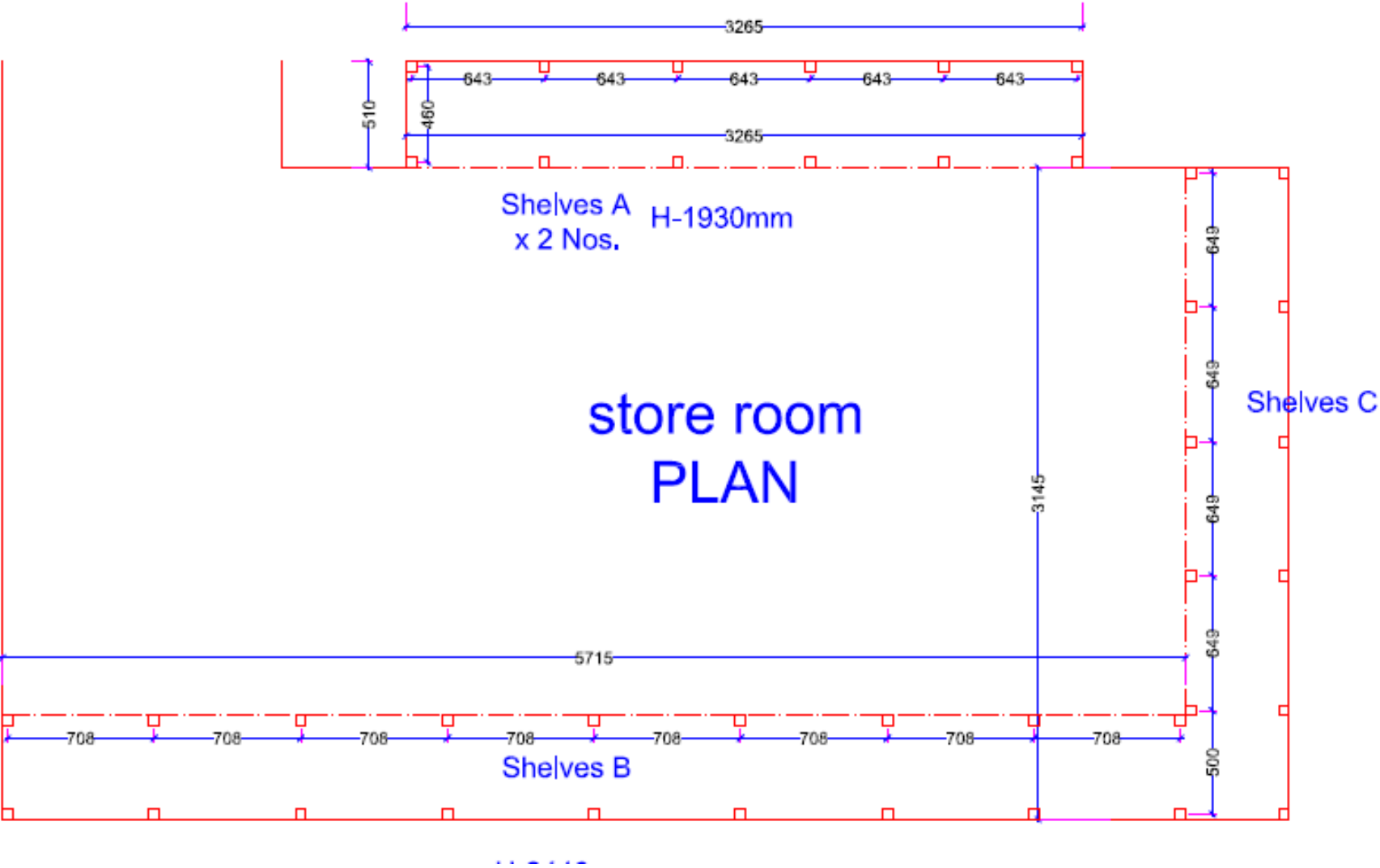

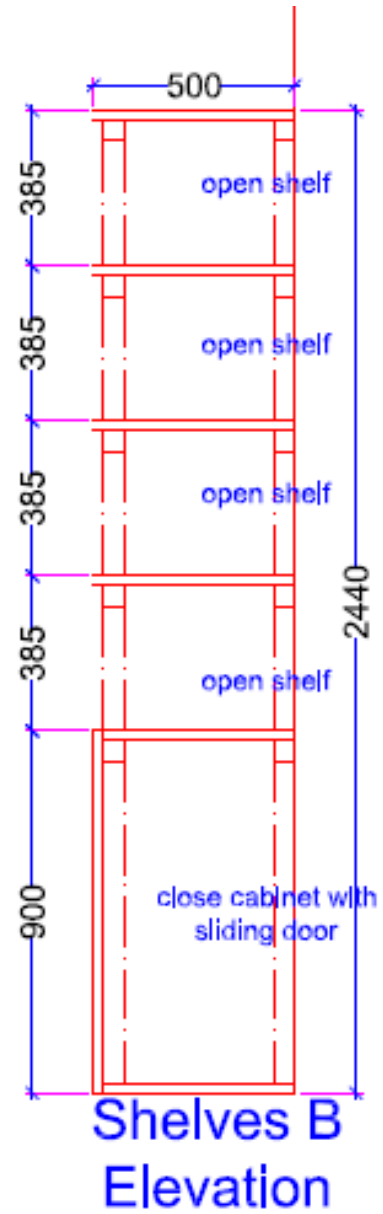
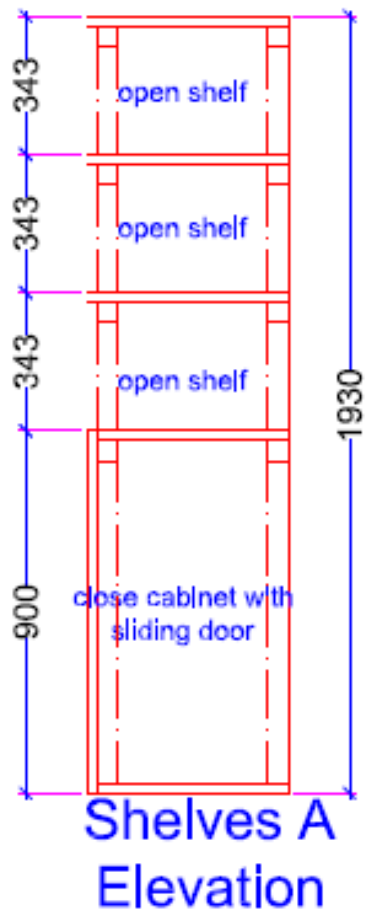

INTEGRITY PACT STATEMENT

Name of Work: Development of FITI Parking Lot.

Sub- Heading: Construction of Retaining Wall and Rigid Pavement, Ventilation works at Basement and Wooden Rack and Ladder at Attic.

1. General

Whereas, **Chief Executive Officer**, representing the **FITI, Thimphu**, hereinafter referred to as the Employer on one part and the **Mr./Miss.** representing **M/s...** **CDB No.** on the other part hereby execute this agreement as follows.

This agreement should be a part of the tender document, which shall be signed and submitted along with the tender document. The head of the employing agency/or his authorized representative should be the signing authority. For the bidders, the bidder himself or his authorized representative must sign the Integrity Pact (IP). If the winning bidder had not signed during the submission of the bid, the tender shall be cancelled.

2. Objectives

Now, therefore, the Employer and the Bidder agree to enter into this pre-contract agreement, hereinafter referred to as Integrity Pact, to avoid all forms of corruption by following a system that is fair, transparent and free from any influence/unprejudiced dealings prior to, during and subsequent to the currency of the contract to be entered into with a view to :-

- 2.1 Enabling the Employer to obtain the desired contract at a reasonable and competitive price in conformity to the defined specifications of the works, goods and services;
- 2.2 Enabling bidders to abstain from bribing or any corrupt practice in order to secure the contract by providing assurance to them that their competitors will also refrain from bribing and other corrupt practices and the Employer will commit to prevent corruption, in any form by their officials by following transparent procedures.

3. Commitments of the Employer:

The Employer Commits itself to the following:-

- 3.1 The Employer hereby undertakes that no official of the Employer, connected directly or indirectly with the contract, will demand, take a promise for or accept, directly or through intermediaries, any bribe, consideration, gift, reward, favor or any material or immaterial benefit or any other advantage from the Bidder, either for themselves or for any person, organization or third party related to the contract in exchange for an advantage in the bidding process, bid evaluation, contracting or implementation process related to the Contract.
- 3.2 The Employer further confirms that its officials has not favored any prospective bidder in any form that could afford an undue advantage to that particular bidder during the tendering stage, and will further treat all Bidders alike.
- 3.3 All the officials of the Employer shall report to the head of the employing agency or an appropriate Government office any attempted or completed violation of clauses 3.1 and 3.2.

- 3.4 Following report on violation of clauses 3.1 and 3.2 by official (s), through any source, necessary disciplinary proceedings, or any other action as deemed fit, including criminal proceedings may be initiated by the Employer and such a person shall be debarred from further dealings related to the contract process. In such a case while an enquiry is being conducted by the Employer the proceedings under the contract would not be stalled

4. Commitments of Bidders

The Bidder commits himself to take all measures necessary to prevent corrupt practices, unfair means and illegal activities during any stage of his bid or during any pre-contract or post-contract stage in order to secure the contract or in furtherance to secure it and in particular commits himself to the following :-

- 4.1 The Bidder will not offer, directly or through intermediaries, any bribe, gift, consideration, reward, favor, any material or immaterial benefit or other advantage, commission, fees, brokerage or inducement to any official of the Employer, connected directly or indirectly with the bidding process, or to any person, organization or third party related to the contract in exchange for any advantage in the bidding, evaluation, contracting and implementation of the Contract.
- 4.2 The Bidder further undertakes that he has not given, offered or promised to give, directly or indirectly any bribe, gift, consideration, reward, favor, any material or immaterial benefit or other advantage, commission, fees, brokerage or inducement to any official of the Employer or otherwise in procuring the Contract or forbearing to do or having done any act in relation to the obtaining or execution of the Contract or any other contract with the Government for showing or forbearing to show favor or disfavor to any person in relation to the Contract or any other contract with the Government.
- 4.3 The Bidder will not collude with other parties interested in the contract to preclude the competitive bid price, impair the transparency, fairness and progress of the bidding process, bid evaluation, contracting and implementation of the contract.
- 4.4 The Bidder, either while presenting the bid or during pre-contract negotiations or before signing the contract, shall disclose any payments he has made, is committed to or intends to make to officials of the Employer or their family members, agents, brokers or any other intermediaries in connection with the contract and the details of services agreed upon for such payments.

5. Sanctions for Violation

Any breach of the aforesaid provisions or providing false information by employers, including manipulation of information by evaluators, shall face administrative charges and penal actions as per the existing relevant rules and laws. The breach of the Pact or providing false information by the Bidder or any one employed by him or acting on his behalf (whether with or without the knowledge of the Bidder) or the commission of any offence by the Bidder or any one, employed by him or acting on his behalf, shall be dealt with as per the provisions of the Bhutan Penal Code 2004, and the Anti-Corruption Act, 2006.

The Employer/relevant agency shall also take all or any one of the following actions, wherever required:-

- 5.1 To immediately call off the pre-contract negotiations without assigning any reason or giving any compensation to the Bidder. However, the proceedings with the other Bidder(s) would continue.

- 5.2 To immediately cancel the contract, if already awarded/signed, without giving any compensation to the Bidder.
- 5.3 To recover all sums already paid by the Employer.
- 5.4 To encash the advance bank guarantee and performance bond/warranty bond, if furnished by the Bidder, in order to recover the payments, already made by the Employer, along with interest.
- 5.5 To cancel all or any other Contracts with the Bidder.
- 5.6 To debar the Bidder from entering into any bid from the government of Bhutan as per the Debarment Rule.

6. Conflict of Interest

- 6.1 A conflict of interest involves a conflict between the public duty and private interests (for favor or vengeance) of a public official, in which the public official has private interest which could improperly influence the performance of their official duties and responsibilities. Conflict of Interest would arise in a situation when any concerned members of both the parties are related either directly or indirectly, or has any association or had any confrontation. Thus, conflict of interest of any tender committee member must be declared in the prescribed form (attached).
- 6.2 The Bidder shall not lend to or borrow any money from or enter into any monetary dealings or transactions, directly or indirectly, with any committee member, and if he does so, the Employer shall be entitled forthwith to rescind the Contract and all other contracts with the Bidder.

7. Examination of Books of Accounts

- 7.1 In case of any allegation of violation of any provisions of this Integrity Pact or payment of commission, the Employer/authorized persons or relevant agencies shall be entitled to examine the Books of Accounts of the Bidder and the Bidder shall provide necessary information of the relevant financial documents and shall extend all possible help for the purpose of such examination.

8. Monitoring and Arbitration

- 8.1 The respective procuring agency shall be responsible for monitoring and arbitration of IP as per the Procurement Rule.

9. Legal Actions

- 9.1 The actions stipulated in this Integrity Pact are without prejudice to any other legal action that may follow in accordance with the provisions of the extant law in force relating to any civil or criminal proceedings.

10. Validity

- 10.1 The validity of this Integrity Pact shall cover the tender process and extend until the completion of the contract to the satisfaction of both the Employer and the Bidder.
- 10.2 Should one or several provisions of this Pact turn out to be invalid; the remainder of this Pact remains valid. In this case, the parties will strive to come to an agreement to their original intentions.

We hereby declare that we have read and understood the clauses of this agreement and the information provided in this agreement are true and correct to the best of our knowledge and belief. In case any information is found incorrect, we assume full responsibility thereof and shall be liable for penalties as per clause 5 of this agreement.

The parties hereby sign this Integrity Pact at _____ on _____

EMPLOYER

BIDDER

(Affix Legal Stamp)

(Affix Legal Stamp)

Witness:

Witness:

1. _____
(Name and CID No.)

1. _____
(Name and CID No.)